

# BUZIOS

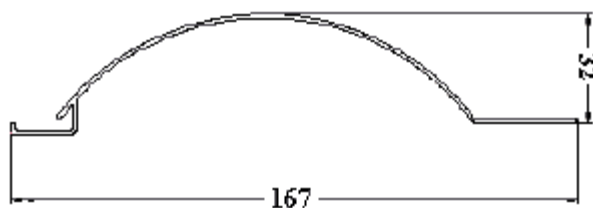

**MASTER  
ALUMÍNIO**

**Soluções sob medida**



**LB-19652**

**0,795 Kg/m**

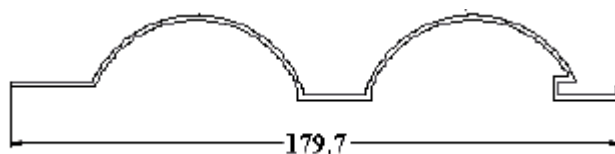

**LB-19575**

**0,892 Kg/m**

# BUZIOS



**MASTER  
ALUMÍNIO**

**Soluções sob medida**

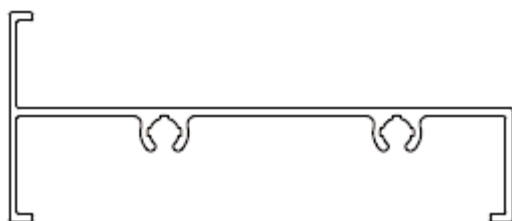

**25-518**

**0,380 Kg/m**

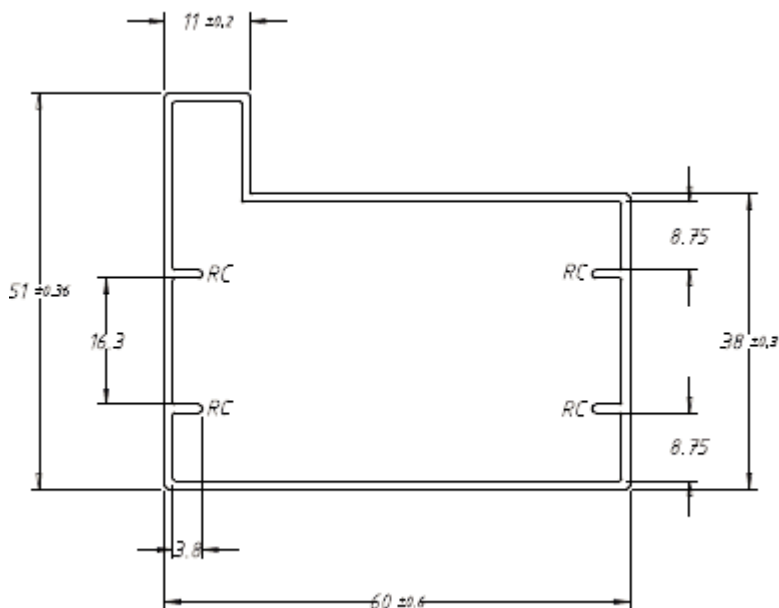

**PC-028**

**0,670 Kg/m**

# BUZIOS



**MASTER  
ALUMÍNIO**

Soluções sob medida



30-044  
0,264 Kg/m

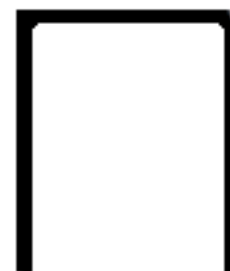

PU-639  
0,389 Kg/m

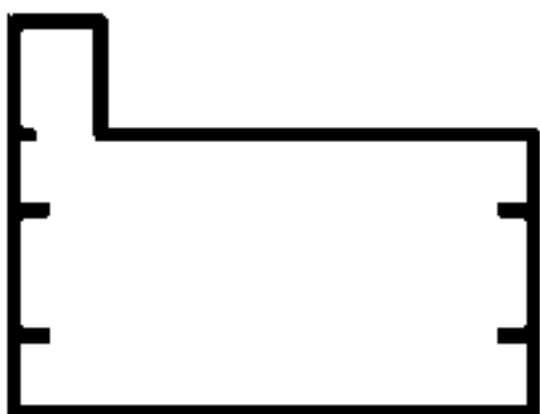

PC-010  
0,800 Kg/m

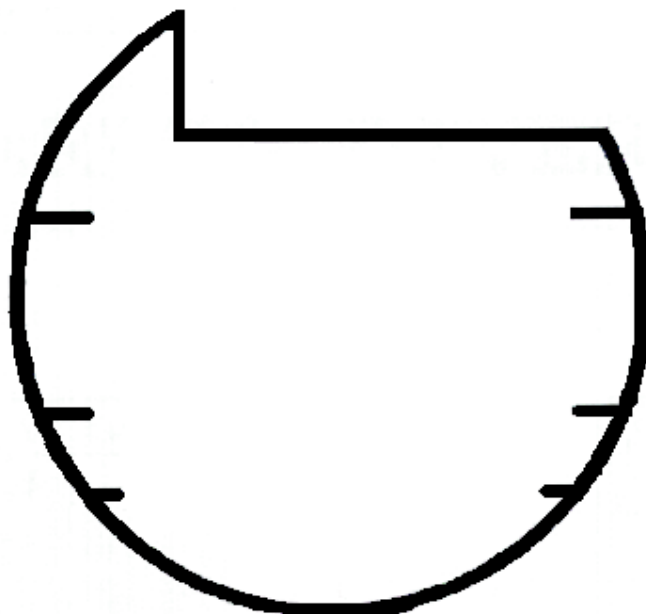

PC-012  
1,080 Kg/m

# BUZIOS



**MASTER  
ALUMÍNIO**

Soluções sob medida

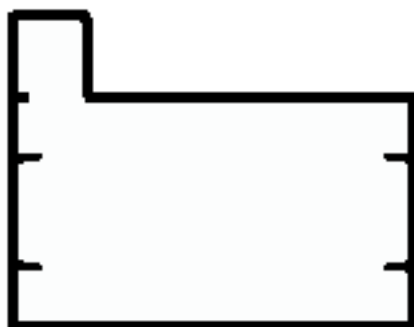

PC-027

0,800 Kg/m